

Sc

# Science test

KEY STAGE

2

LEVELS

3-5

## Test A

First name \_\_\_\_\_

Last name \_\_\_\_\_

School \_\_\_\_\_

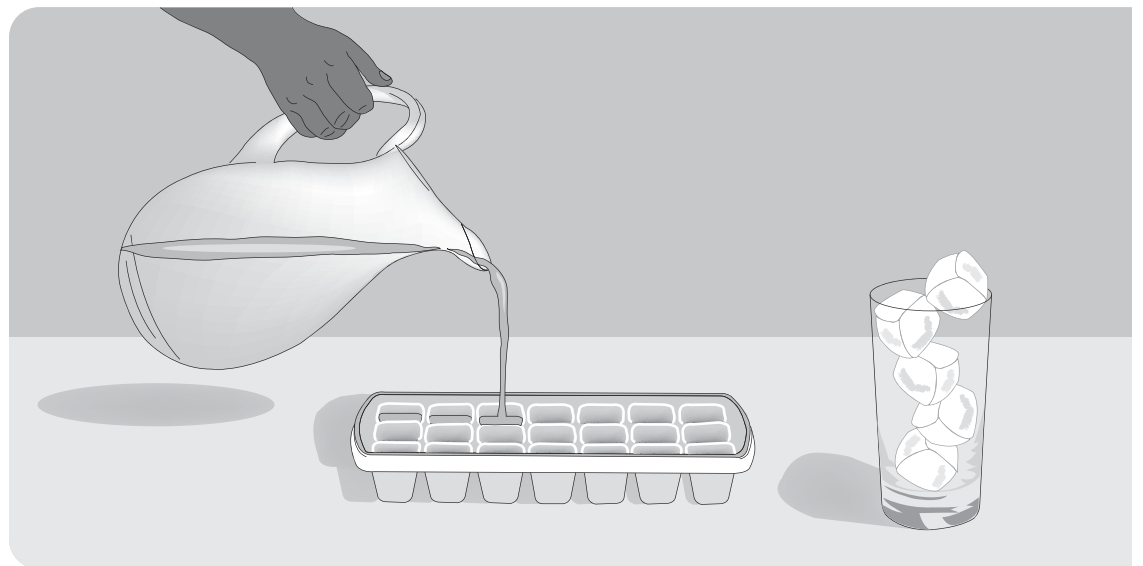

For marker's use only

Page	Marks
5	
7	
9	
11	
13	
15	
17	
19	
20	
<b>TOTAL</b>	

2009

# INSTRUCTIONS

Read this carefully.

You have **45 minutes** for this test.

## Answers



This pencil shows where you will need to put your answer.

For some questions you may need to draw an answer instead of writing one.

Some questions may have a box like this for you to write down your thoughts and ideas.

A large, empty rounded rectangular box intended for students to write their thoughts and ideas.

## Human body

(a) Rohan is wearing an apron showing different parts of the body.

(i) Tick **ONE** box to show which body part is the heart.

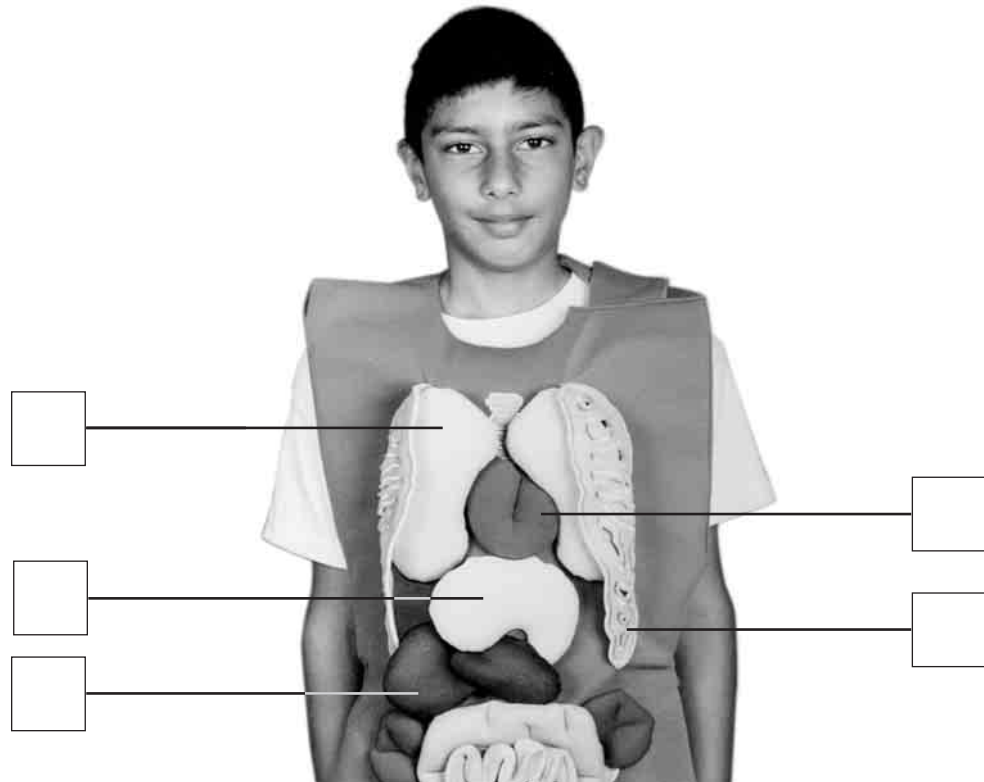

1ai  
1 mark

(ii) Describe the function of the heart in the human body.



.....

.....

1aii  
1 mark

(b) Rohan thinks about other parts of the human body.

Which of these things would do **most** damage to the **lungs**?

Tick **ONE** box.



drinking alcohol

smoking cigarettes

eating fatty food

not exercising

1b  
1 mark

(c) Why does brushing teeth help to reduce tooth decay?



.....  
.....

1c  
1 mark

(d) Complete each sentence using a word from the box below it.



(i) The skeleton is moved by the ..... when the body moves.

**legs      arms      bones      muscles**

1di  
1 mark



(ii) The bones in the skeleton are ..... so that they can support the body.

**straight      long      rigid      curved**

1dii  
1 mark

## Toy truck

- (a) Jo turns a key to wind up a toy truck.

When she lets go of the key the truck moves forward on the carpet.

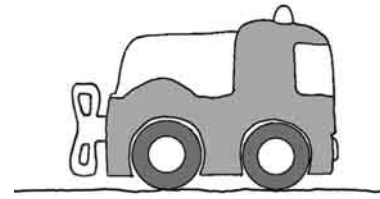

Jo wants to find out if the number of complete turns of the key affects the distance the truck travels.

Tick **TWO** boxes to show which **two** things Jo **must** keep the same to make her test fair.



toy truck

person winding the key

tape measure

the surface the truck is on

 2a  
1 mark

- (b) This graph shows Jo's results.

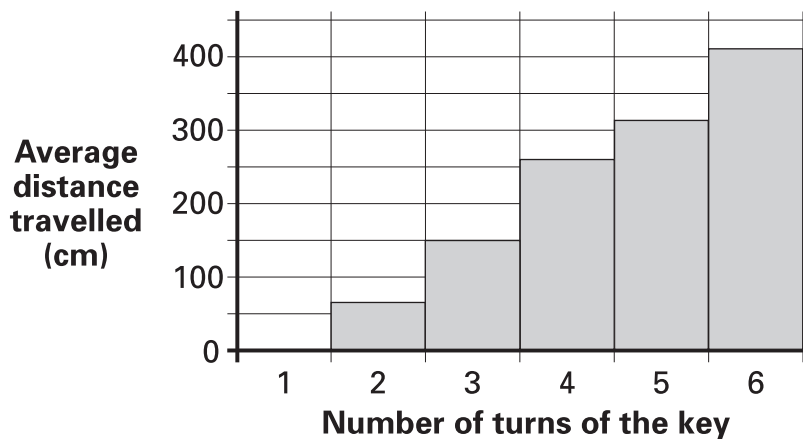

How does the **number of turns** of the key affect the **average distance** the truck travels?



.....

.....

 2b  
1 mark

- (c) Jo repeats the test on a wooden floor.  
She predicts, 'The truck will travel the same distance on the smooth wooden floor as on the carpet.'

The table shows how far the truck travels for different numbers of turns of the key.

Number of turns of key	Average distance travelled (cm)	
	on carpet	on wood
1	0	110
2	66	242
3	150	363

- (i) Do the measurements in the table support Jo's prediction?



yes

no

- (ii) Explain your answer using examples from the table.



.....

.....

 2c  
1 mark

- (d) Why are the results different on carpet and wood?

Write about the force of **friction** in your answer.



.....

.....

 2d  
1 mark

## In the garden

- (a) Fiona is in the garden. She wonders how she can find out the names of some of the plants.

Tick **ONE** box to show how Fiona could find out the names of the plants.

 Fiona could use a...

food chain.

producer.

fair test.

key.

3a  
1 mark

- (b) Fiona sorts the plants into groups to help her find out their names. The plants in one of her groups all have yellow flowers.

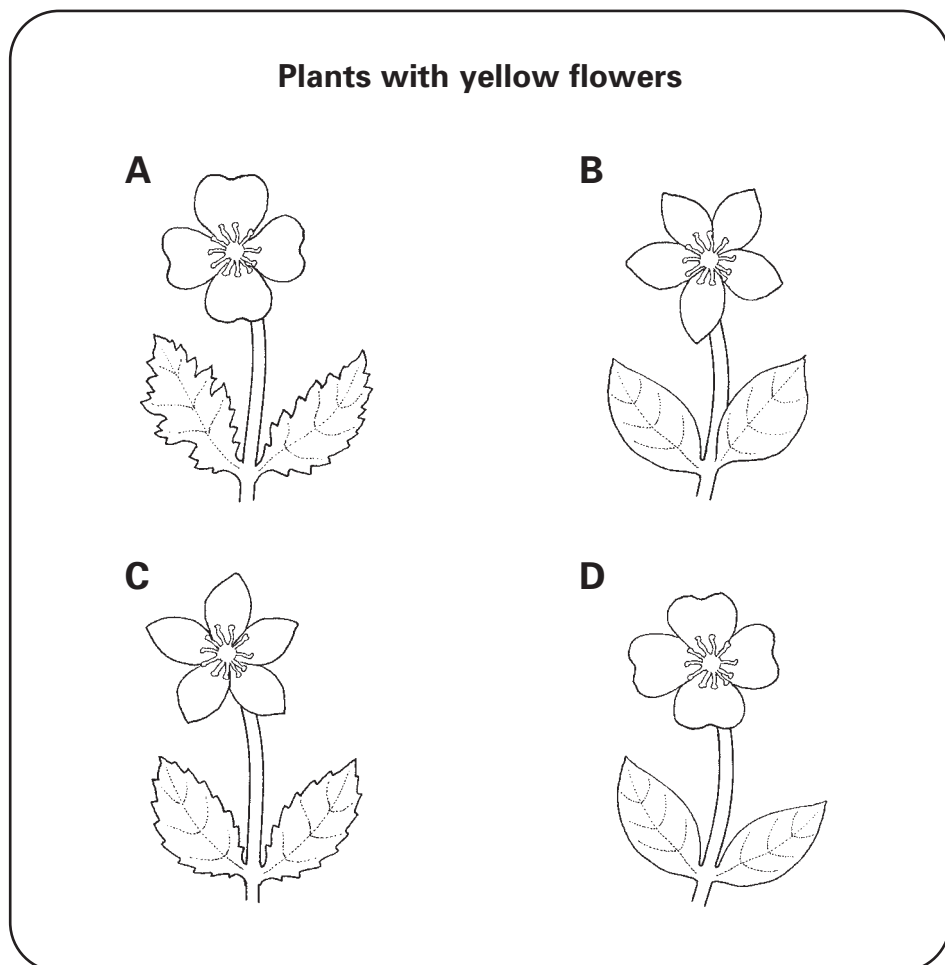

Look at the group of plants with yellow flowers.  
Fiona needs to sort these plants into two groups.

- (i) Suggest a way these plants with yellow flowers could be sorted into two groups.



**Group 1: Plants with yellow**      **Group 2: Plants with yellow**

**flowers and .....**      **flowers and .....**

.....

- (ii) Write **A, B, C** or **D** in each box below to show how Fiona should sort the plants with yellow flowers into the two groups you gave above.



**Group 1**

<input type="text"/>	<input type="text"/>
----------------------	----------------------

**Group 2**

<input type="text"/>	<input type="text"/>
----------------------	----------------------

3bi  
1 mark

3bii  
1 mark

- (c) Scientists sort plants into groups.  
Tick **ONE** box to show why it is a good idea.



to compare plants with animals

to see if a plant is a living thing

in case a plant dies

because there are many types of plant

3c  
1 mark



## Ice melting

Andrew has some tubs of ice cubes.  
He can put the tubs with ice into  
different bags.

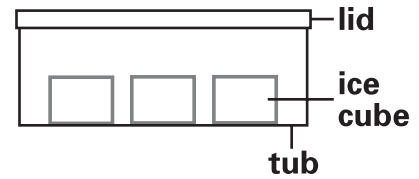

He wants to find out which bag is best  
at stopping the ice from melting quickly.

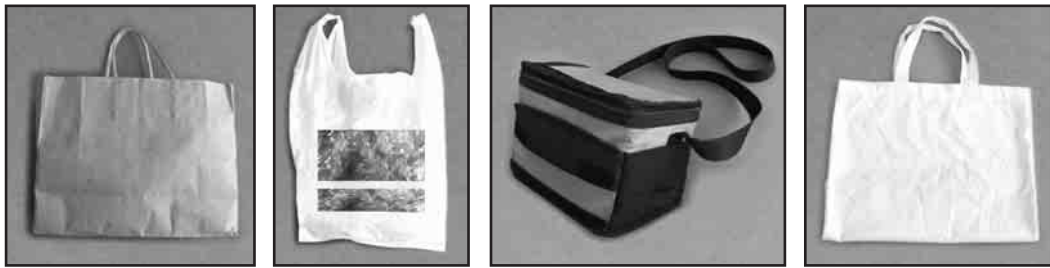

Plan an investigation to find out which bag is best at stopping the  
ice in the tubs from melting quickly.

You must measure your results with a  
stopwatch or a measuring cylinder or both.  
You have no other equipment.



measuring  
cylinder

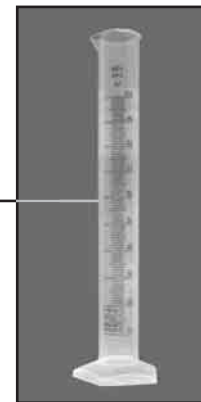

You can use the draft box below to plan your investigation.

A large, empty rounded rectangular box with a thin black border, intended for writing a plan for the investigation. A small pencil icon is located at the top left corner of the box.

Use your draft to help you complete the plan on the next page.

**My plan for the investigation with ice.**

(a) Circle the correct word in each box to complete the sentences.

 The best bag will 

<b>conduct</b>
<b>insulate</b>

 well.

It will stop 

<b>cold</b>
<b>heat</b>

 passing from the air to the ice.

4a  
1 mark

(b) The variable I will change in my investigation is:

 .....

4b  
1 mark

(c) The variable I will measure with the equipment is:

 .....

4c  
1 mark

(d) **TWO** variables I will keep the same to make my investigation fair are:

 (i) .....

4di  
1 mark

(ii) .....

4dii  
1 mark

(e) It would be a good idea to do the investigation more than once because:

 .....  
.....

4e  
1 mark

## Torch light

- (a) Sanna is investigating which materials are good reflectors of light. She shines a torch on different objects from a distance of 20 cm.



She looks at the objects to see how well each reflects light.

Tick **TWO** boxes to show which objects are the **best** reflectors.

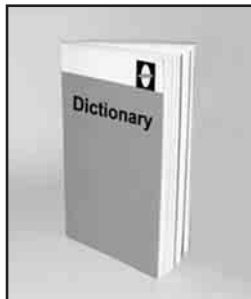

**Paper book**



**Metal spoon**

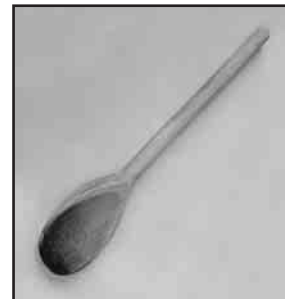

**Wooden spoon**



**Woolly hat**



**Glass jar**



**Compact disc**

5ai  
1 mark

5aii  
1 mark

(b) Tick **ONE** box to show which of Sanna's objects does **not** make a dark shadow.



metal spoon

wooden spoon

woolly hat

glass jar

5b  
1 mark

(c) The picture below shows Sanna looking at the torch light reflected in a mirror.

Draw **TWO arrows** to show the direction the light must travel for Sanna to see light from the torch in the mirror.

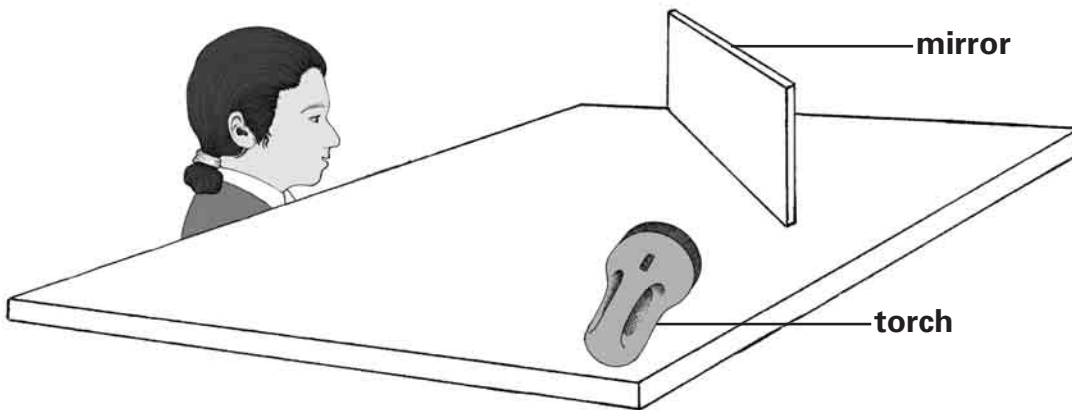

5ci  
1 mark

5cii  
1 mark

## Quiz board

(a) Lori makes an electrical quiz board like the one below.

She writes a question on the flap of paper.

Then she writes four answers next to the letters A, B, C and D.

Only one answer is correct.

When the wire touches the metal clip next to the correct answer, the bulb lights brightly.

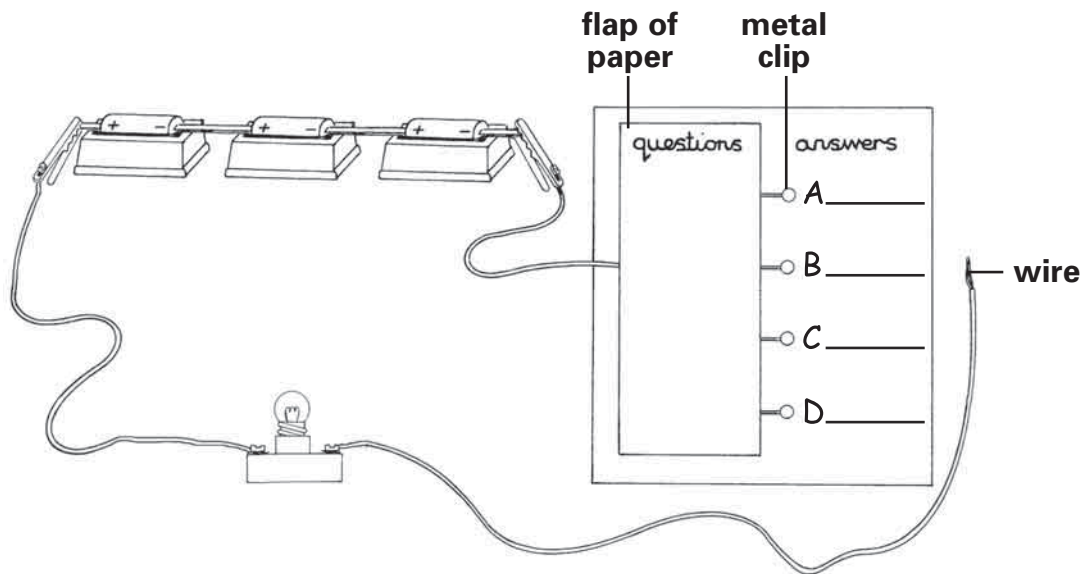

When she lifts the flap of paper, you can see how the circuit is made.

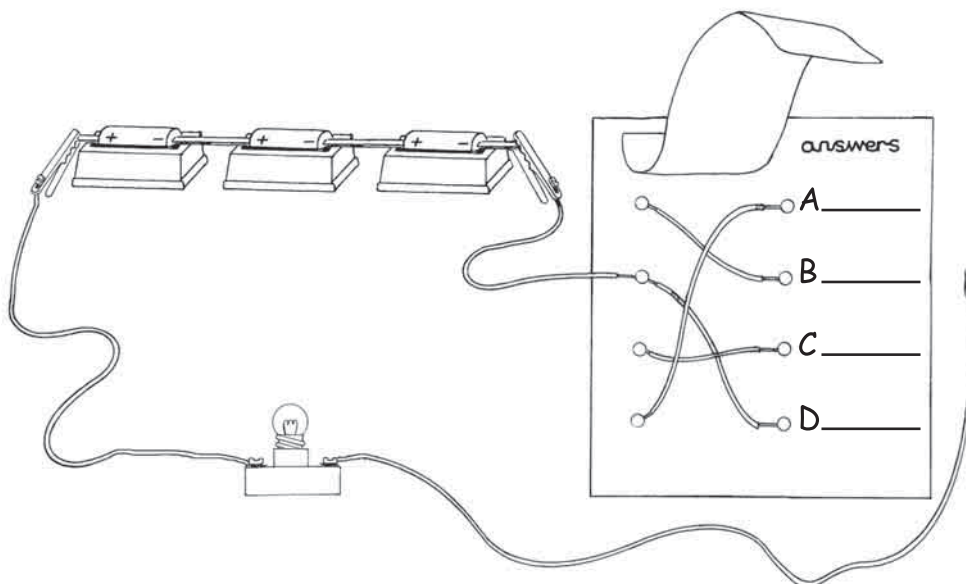

Look at the diagrams.

Which metal clip must Lori touch with the wire to complete the circuit? Tick **ONE** box.



A

B

C

D

6a

1 mark

(b) Lori removes one cell (battery) from her circuit.

How will taking one cell out of Lori's circuit affect the bulb when it is lit?



.....

6b

1 mark

(c) Lori tries to improve the quiz board. She puts sticky tape over the metal clips A, B, C and D to keep them in place.

She tests the quiz board. It does not work.

Explain why the sticky tape stops Lori's quiz board from working.



.....

.....

6c

1 mark

## Growing beans

- (a) Ann and Jake investigate how beans germinate and grow. They each put a bean seed in a jar with paper. They observe their bean seeds for 12 days. Ann does **not** water her bean seed.

Tick **ONE** box to predict how long the root and shoot of Ann's seed will be if she **never** waters it.



Length of root: 1 cm   
Length of shoot: 4 cm

Length of root: 0 cm   
Length of shoot: 4 cm

Length of root: 4 cm   
Length of shoot: 1 cm

Length of root: 0 cm   
Length of shoot: 0 cm

7a  
1 mark

- (b) Jake waters his bean seed every day.



Label the diagram of Jake's bean. Write **root**, **shoot** and **seed**.

7b  
1 mark

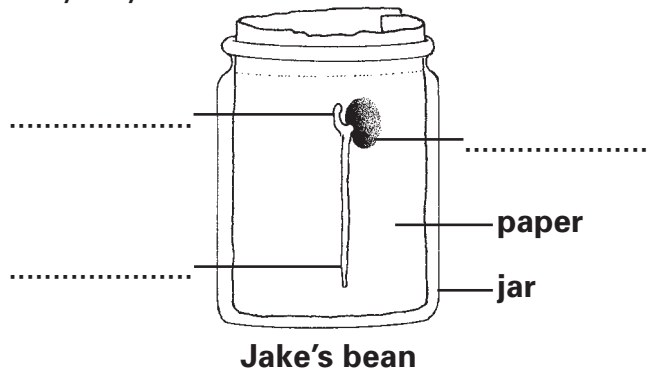

- (c) Jake measures the lengths of the root and shoot and records these in a table.

Day	2	4	6	8	10	12
Length of root (cm)	0	0	2.5	6.6	10.2	13.0
Length of shoot (cm)	0	0	0	0	1.4	5.0

On which day did Jake **record** that his bean seed had germinated?

7c  
1 mark



.....

(d) Jake uses the information from his table to draw a bar graph.

Use the table to complete Jake's key to show what the grey and black bars on the graph mean.

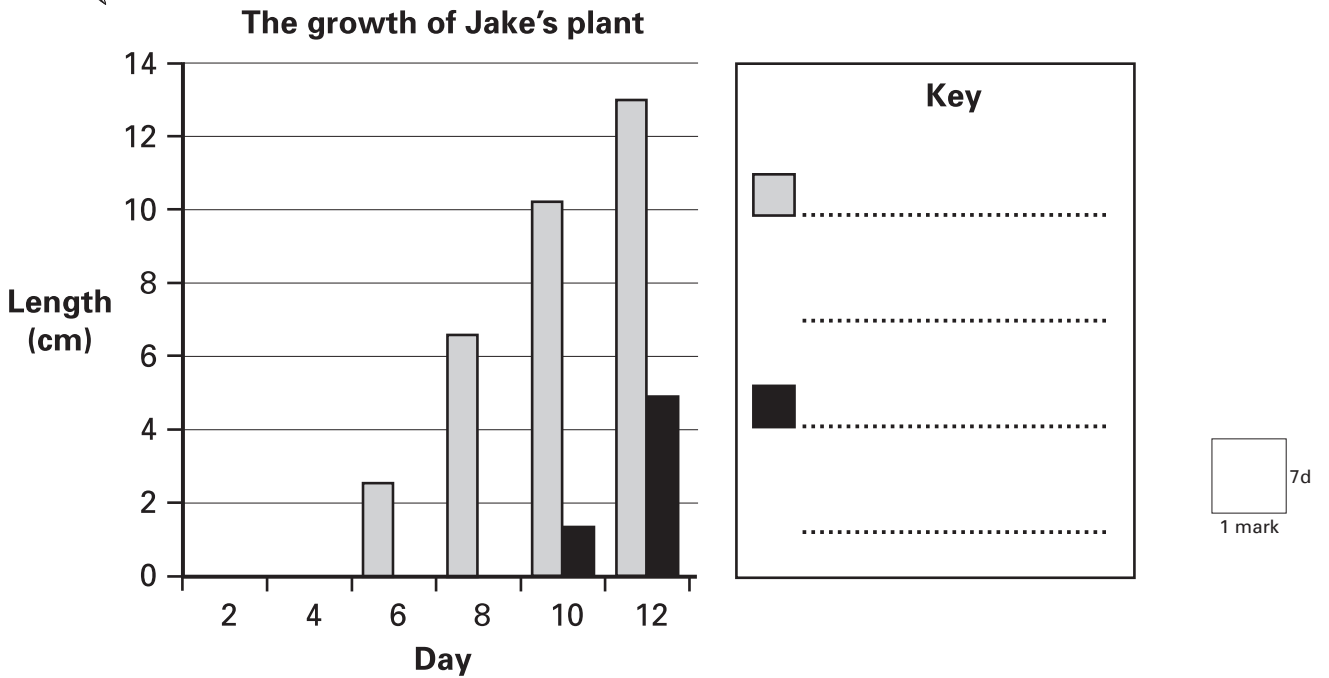

(e) Jake puts his plant in soil.  
After a few weeks, there is a flower on Jake's plant.

Tick **ONE** box to show the **next stage** in the life cycle of Jake's plant.



- |   |  |
|---|--|
| seed dispersal <input style="width: 40px; height: 30px;" type="checkbox"/>  | fruit production <input style="width: 40px; height: 30px;" type="checkbox"/> |
| seed production <input style="width: 40px; height: 30px;" type="checkbox"/> | pollination <input style="width: 40px; height: 30px;" type="checkbox"/>      |
- 7e  
 1 mark



## Block tower game

- (a) Suzy and Peter are playing a game with a tower of wooden blocks.

They take turns to pull a block out of the tower and put the block back on top of the tower.

Suzy pulls a block out of the tower.

Suzy says, 'Some blocks are easier to pull out of the tower than others.'

What kind of statement has Suzy made? Tick **ONE** box.



a prediction

an observation

a plan

a conclusion

8a  
1 mark

- (b) Some blocks are more difficult to pull out because of friction.

Draw **ONE** arrow on the picture to show the direction of **friction** on the block that Suzy pulls out of the tower.

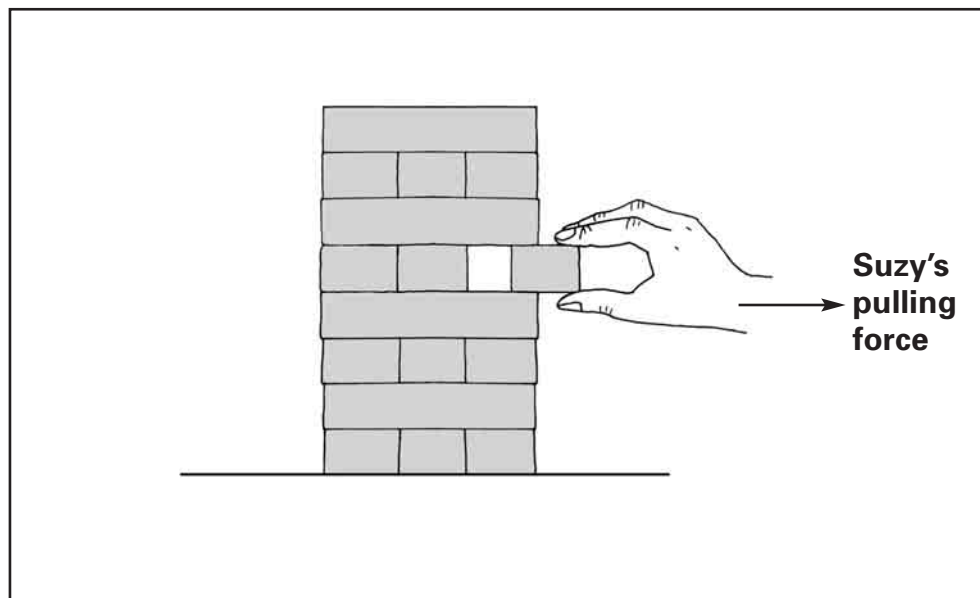

8b  
1 mark

(c) Name the equipment that Suzy could use to measure the force needed to pull the block out of the tower.



.....

8c  
1 mark

(d) The game ends when someone pulls a block out of the tower and the tower falls over.



What is the name of the force that causes the blocks to fall?



.....

8d  
1 mark

(e) The blocks are solid.

Tick **ONE** box to show a property of **all** solids.



All solids keep their shape.

All solids are heavy.

All solids are waterproof.

All solids are hard.

8e  
1 mark

## Identifying rocks

Tom has five different rocks.

He describes their properties in the table below.

Rock	Colour	Texture	Hardness Does a coin scratch it?
A	black, pink, grey	rough	no
B	white	smooth	yes
C	black	smooth	no
D	black	rough	yes
E	white	rough	no

Write **A, B, C, D** or **E** in each box on the sorting diagram below to identify the rocks.

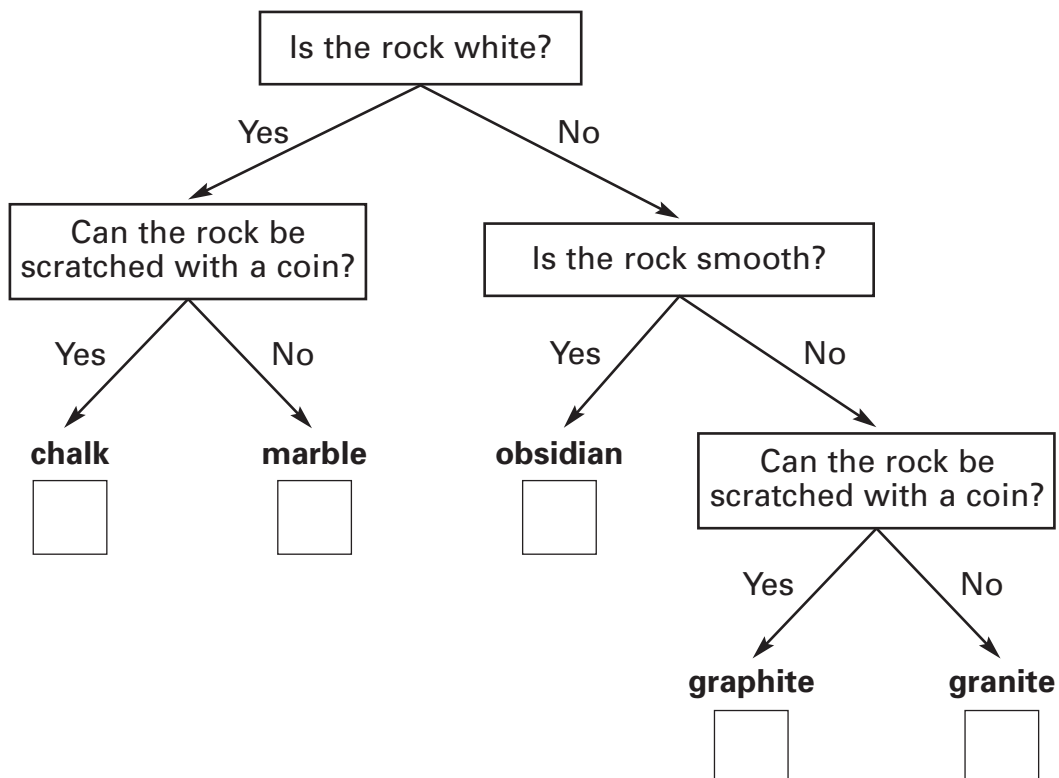

9i  
1 mark

9ii  
1 mark

Total out of 2  
Sourced from SATs-Papers.co.uk

**END OF TEST**

**Please check your answers**

**[Blank page]**

**[Blank page]**

