

Key stage 3 mathematics 2008

Mental mathematics Test B

First name _____

Last name _____

School _____

Total marks

Practice question

		99
--	--	----

Time: 5 seconds

1		<input type="text"/>
---	--	----------------------

2	4.7, 4.8, 4.9, _____, _____	<input type="text"/>
---	-----------------------------	----------------------

3		$4pq$
---	--	-------

4		$\frac{7}{100}$
---	--	-----------------

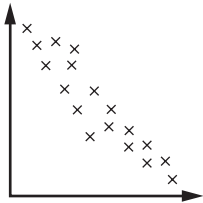
5		
	None Gradient High Positive Negative	<input type="text"/>

Time: 5 seconds continued

6	%	10 out of 25	<input type="text"/>
---	---	--------------	----------------------

Time: 10 seconds

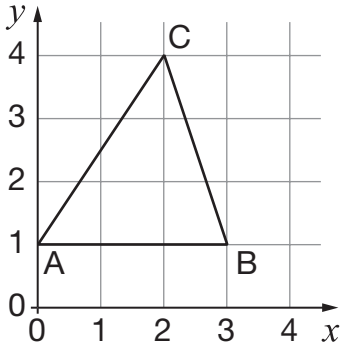
7		
	(,)	<input type="text"/>

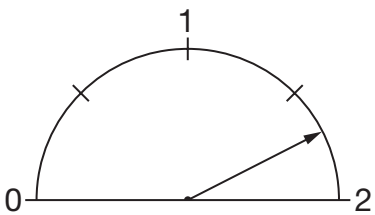
8		
	<input type="text"/>	<input type="text"/>

9	£	£3.60	<input type="text"/>
---	---	-------	----------------------

10	mm	10cm	<input type="text"/>
----	----	------	----------------------

11		2.9
----	--	-----

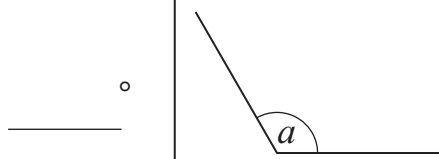
12		
	<input type="text"/>	<input type="text"/>

13	$\frac{1}{5}$	2	<input type="text"/>
----	---------------	---	----------------------

14		148
----	--	-----

Time: 10 seconds continued

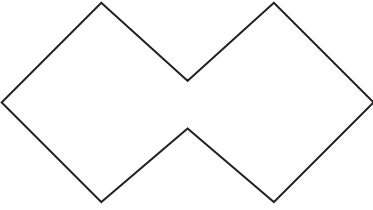
15 

16 17 red
13 green

17 36

18 $21 - 3x = 9$

19 2 cm Scale factor 2
 cm^2

20 $(x + 2)(x - 1)$

21 10cm^2 90cm^3
 cm

Time: 15 seconds

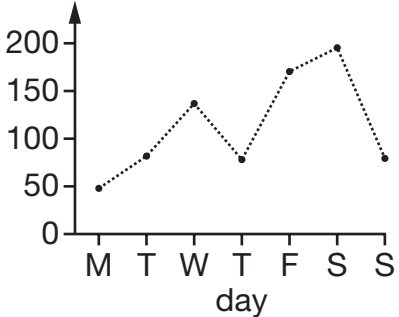
22 
days

Time: 15 seconds continued

23

24 40p for 5 minutes
 £

25 $\frac{3}{5}$ $\frac{4}{5}$ $\frac{5}{6}$ $\frac{6}{9}$ $\frac{7}{10}$

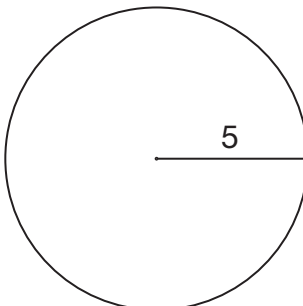
26 
 5π 10π 15π
 25π 100π

27 £ 1 : 4 : 5

28 $\frac{39.92 \times 41.06}{1.98}$

29 -20 80 40

30 